

DETECTION OF EXTRAORDINARY LARGE BIO-MAGNETIC FIELD STRENGTH
FROM HUMAN HAND
DURING EXTERNAL QI EMISSION

Akira SETO, Ph.D., Assistant Professor, Showa University

Chikaaki KUSAKA, M.D., Director, Magnetomedicine and Physical
Therapy Laboratory

Seiki NAKAZATO, M.S., Director, Japan Qi Gong Association

Wei rong HUANG, Research Fellow, Dept. of Physiology

Takao SATO, Ph.D., Assistant Professor, Dept. of Physiology

Tadashi HISAMITSU, M.D., Ph.D., Professor and Chairman,
Dept. of Physiology

Chifuyu TAKESHIGE, M.D., Ph.D., Honorary Professor,
Former Dean of Medicine, Showa University,
F.I.C.A.E.

Department of Physiology, School of Medicine, Showa University
1-5-8, Hatanodai, Shinagawa-ku, Tokyo, 142, JAPAN

(Received April 9, 1992; Accepted with revisions April 30, 1992)

ABSTRACT:

It is generally accepted that more than 10^{-6} gauss order magnetism was not detected in normal human condition. However, we detected 10^{-3} gauss (mGauss)

order bio-magnetic field strength from the palm in special persons who emitted External Qi ("Chi" or "Ki"). This detection was possible by special arranged magnetic field detection system, consisted of a pair of 2 identical coils with 80,000 turns and a high sensitivity amplifier. Each of the coils were rolled 80,000 turns accurately, and were connected in series in opposite direction, actuating as a gradiometer. We measure bio-magnetic field strength in 37 subjects with this detection system. The only 3 subjects of them exhibited strong bio-magnetic field of 2 to 4 mGauss in frequency range of 4 to 10 Hz. This magnetic field strength was greater than that of normal human bio-magnetism by 1,000 times at least. A simultaneous measurement of bio-magnetic field strength and its corresponding bio-electric current was examined in one subject. During exhibiting such strong bio-magnetism, its corresponding electric current was not detectable. Therefore, the extraordinary large bio-magnetic field strength can not derive from internal body current alone, hence the origin of the large bio-magnetism is still unknown. We suppose that the extraordinary large bio-magnetic field strength might be originated from "Qi" energy in the oriental medicine or in the oriental traditional philosophy.

Key words: Extraordinary large bio-magnetism, Magnetic field, Qi, Qi emission, External Qi, Qi Gong, Zen, Meditation, Yoga, Oriental medicine, Magnetometry

INTRODUCTION

It is known that human body radiates less than 10^{-6} gauss order magnetic field strength accompanying action of organs such as the brain, heart, muscle and etc. in normal condition [1-3]. Different from such magnetism, the stronger magnetic field which estimated from effect of the External Qi (外氣) on the therapeutic use [4-6] might radiate from special persons who emitted external "Qi(氣)".

In the present study, we tried to find such extraordinary

bio-magnetism by a special arranged magnetic field strength detection system.

MATERIALS AND METHODS

1. Extraordinary Bio-magnetic Field Strength Detection System Consisting of Following :

i) A pair of 2 identical coils with 80,000 turns connected in series in opposite direction (Figure 1) :

Two coils accurately rolled 80,000 turns were made for sensing magnetism (Fig.1). The coil was 75mm in diameter, 80mm in length, and was rolled by the enameled wire of 0.1mm in diameter. Core of the coil was ferrite of 15mm square in cross section, was 100mm in length.

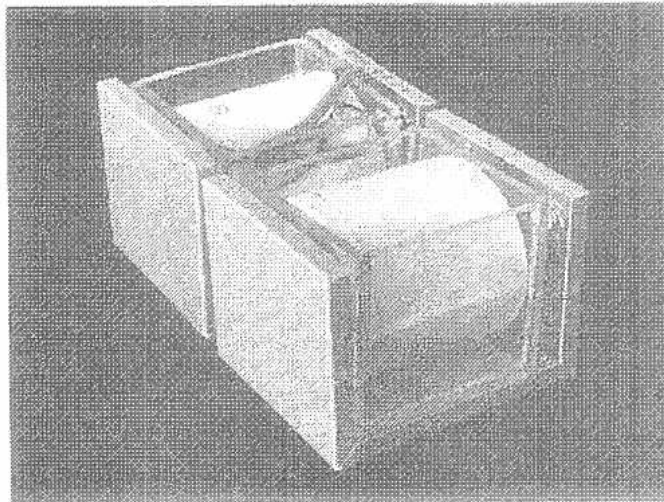

Fig. 1 : A pair of two identical coils with 80,000 turns, connected in series in opposite direction.

The two coils (Coil-1, Coil-2, in Figure 2) were connected in series in opposite direction, actuating as a

gradiometer [1-3].

The uniform magnetic background noises coming from faraway place were almost canceled due to the two equal voltages of each opposite polarity which were generated independently in each other's coil (Figure 3). On the other hand, the desired induced voltage from the nearby measured area on the human body was not canceled, since the voltage difference was produced between the two coils [1-3].

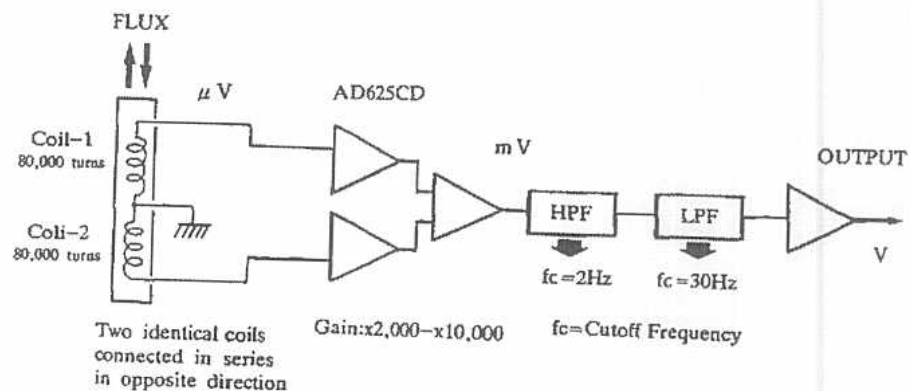

Fig. 2 : Diagram of a pair of two identical coils and high sensitivity amplifier.

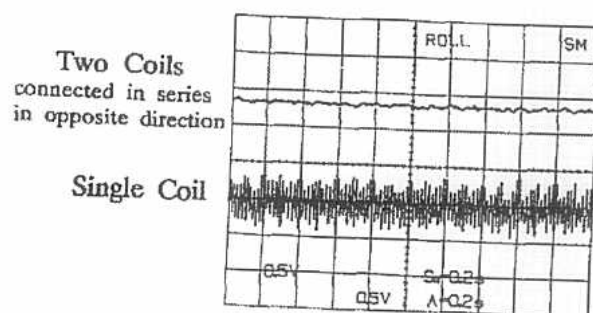

Fig. 3 : Background noise canceling effect using a pair of two identical coils which are connected in series in opposite direction, as a Gradiometer [1-3].

ii) High sensitivity amplifier (Figure 2 and 4) :

Fig. 2 shows a diagram of the high sensitivity amplifier, was designed specifically for measuring weak alternating low frequency magnetic field.

Figure 4 is an inside view of the amplifier unit. DC characteristic of the first input IC (AD625CD, ANALOG DEVICES Co., Norwood, M.A., USA), is very excellent, since the input offset drift is $0.25\mu\text{V}/^\circ\text{C}$ or less, and the output offset drift is $15\mu\text{V}/^\circ\text{C}$ or less. Moreover, the IC noise characteristic is $0.2\mu\text{V}$ (p-p) (Gain=1000). The IC gain can be set up variably to 10,000 times (+80dB) with no difficulty, by only connecting with one corresponding resistance.

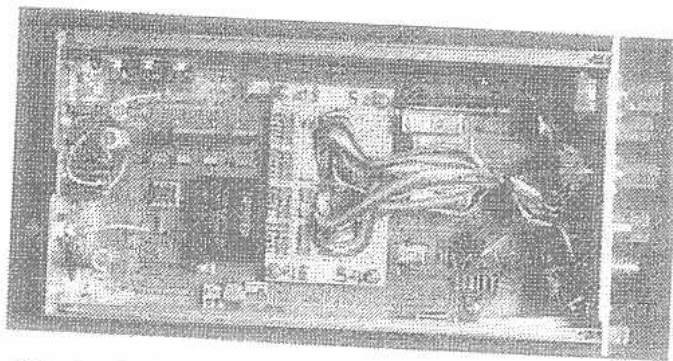

Fig. 4 : Inside view of special arranged amplifier unit.
(Showa University type ; Model 2650).

In this system, high performance 4th-Order filters were arranged as action against external noise. This 4th-Order filter has a sharp cutoff-frequency (f_c) characteristic (Figure 5). That is, if original electric input-signal passes through the 4th-Order filter, the amplitude of the output-signal which is passed through the filter is reduced in inverse proportion to " f^4 " (therefore, called 4th-Order).

A 4th-Order High Pass Filter element (4th-HPF) (Model; FLJ-UR4HB1, Chebyshev type, DATEL Inc., Mansfield, M.A., USA) and a 4th-Order Low Pass Filter element (4th LPF) (Model; FLJ-UR4LB1, Chebyshev type, DATEL Inc.) were used in this amplifier unit.

Cutoff frequencies of the HPF are provided variably with 6 stages of 0.1, 1, 2, 3, 5, 10 Hz. In similar, those of the LPF are provided variably with 6 stages of 10, 15, 20, 30,

100, 1000 Hz. The cutoff frequencies of the HPF and the LPF in the present experiment were held 2Hz and 30Hz respectively. Fig. 5 shows the cutoff frequency characteristics of the 4th-Order HPF ($f_c=2\text{Hz}$) and LPF ($f_c=30\text{Hz}$). In especial, the 4th-Order HPF removed very effectively a drift from DC to the extremely low frequency of below 1.0 Hz ; such a drift derived from body vibration or room rocking.

A magnetometer of MODEL 9500 (F.W.BELL Co., Orlando, F.L., USA) was used for calibration of this system. Our whole magnetometry system ensured the sensitivity of 0.02 mGauss (p-p) finally.

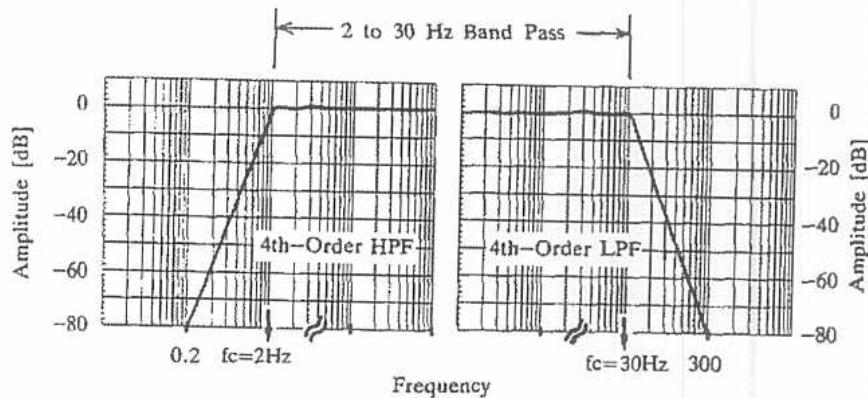

Fig. 5 : Sharp cutoff-frequency (f_c) characteristic of 4th-Order filter. Amplitude of the output-signal passed through the filter, is reduced in inverse proportion to " f^4 ", therefore called 4th-Order.

2. Measurement of Extraordinary Bio-magnetic Field Strength from Human Hand :

We detected magnetic field signals with the above mentioned measure devices by the following methods.

i) Subjects :

Subjects were chosen from persons who were satisfied the following condition.

- 1)The persons who insisted that they can emit the external Qi.
- 2)The persons who thought to have such an ability, too.
- 3)The apparently healthy average citizens.

In the present report, 37 persons cooperated in the present measuring experiments. Those persons consisted of the following groups. Training of Zen (禅), Qi Gong (氣功, known as "Ki-Kou" in Japan), Yoga, Meditation, and related Oriental Traditional Health Exercises.

ii) Composition of bio-magnetic field measurement system (Figure 6) :

A composition of bio-magnetic field measurement system illustrated in Fig.6. The detection system consists of the following units. A pair of 2 coils with 80,000 turns as a sensor (HASHIMOTO Electric Laboratory, Kamakura, Japan), a high sensitivity amplifier (Showa University type; Model 2650, Tokyo, Japan), a digital storage oscilloscope (VC-6025, HITACHI Tokyo, Japan), a high sensitivity amplifier (Showa University type; Model 2650, Tokyo, Japan), a digital storage oscilloscope (VC-6025, HITACHI

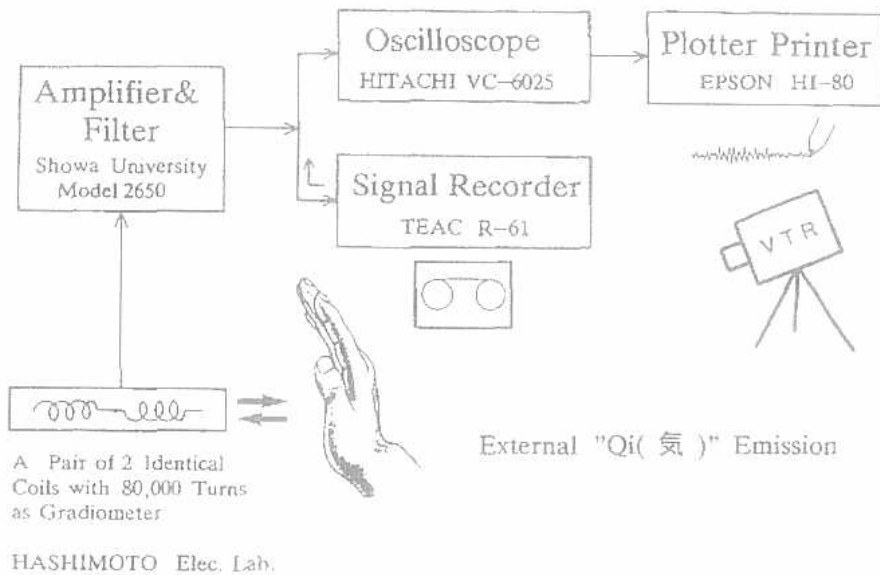

Fig. 6 : Composition of bio-magnetic field emission measurement system.

Electric Co., Tokyo, Japan), a signal recorder (R-61, $\pm 1.5V$ range, frequency characteristic is covered from DC up to 625 Hz in FM Mode, SN ratio is 50 dB, TEAC Co., Tokyo), and a plotter printer (HI-80, EPSON Co., Tokyo). All bio-magnetic field signals were recorded on data recording tapes.

In analysis of the waveform, reproduced waves from the recorder were held on the HITACHI digital storage oscilloscope. Afterwards, the amplitude and the frequency were measured with accessory cursors of the digital storage oscilloscope. Moreover, the wave trace was carried out on the plotter printer. The wave information held on the digital storage oscilloscope was sent out to the plotter printer through RS-232C interface between the digital storage oscilloscope and the plotter printer. The RS-232C interface is a kind of international specification for digital intercommunication. Video camera was used for recording of the experiment view's as necessary.

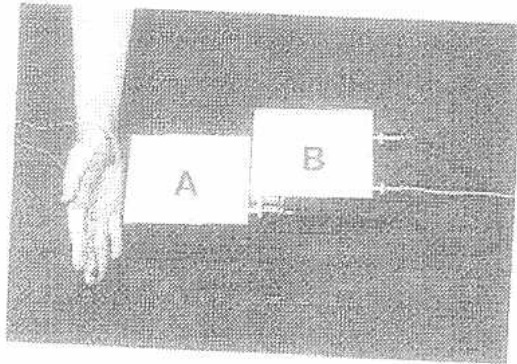

Fig. 7 : Measurement of extraordinary bio-magnetic field emission from the palm.

Two electrodes were attached to the palm for measuring its corresponding bio-electric current simultaneously. The electrodes, the cable, and the electrode paste were made with non magnetic substance only.

A: Coil-1, B: Coil-2.

iii) Actual arrangements for the bio-magnetic field emission measurement :

All the metals were removed from the subjects. While the subject was standing by quietly, the magnetic background fluctuation was recorded for 10 minutes continuously as a control. When the base line was stabilized on oscilloscope, we ordered with sign the subject to initiate the external Qi emission. In case of stopping, we ordered the subject to interrupt the Qi emission with stop signal. The bio-magnetic field strength was measured from the center of the palm of

the right hand (HC_s [or PC_s] , 劳宫, Laokung, [Rokyu in Japanese] [7]). A typical measuring set up is shown in Figure 7.

iv) Simultaneous measurement of bio-electricity :

Moreover, when a bio-electric amplifier was able to be prepared by chance while the magnetic experiment obtained a positive result, we tried detecting not only the magnetic field strength but also its corresponding bio-electricity. Because both of which should be generated simultaneously from the same subject. In this experiment, we detected the electricity by the following methods. Two round silver-chloride plate electrodes of 10 mm in diameter used for EEG recording (45180A, NEC SANEI Co., Tokyo) were attached to the tip of the third finger and the base of the palm with electrode paste (Fig.7). The electrode, the electrode cable and the paste were made with non magnetic substance. An AC bio-amplifier (Polygraph 366 system, MODEL-4124 unit, NEC SANEI Co., Tokyo) was operated with a mode of 0.3 second time constant and 30 Hz high cut off frequency.

RESULTS

Positive results showing significant magnetic field were obtained from 3 of the 37 subjects. Three were ; a male in Sapporo, Japanese, high school teacher, initial name M.T. ; a female in Sapporo, Japanese, female Buddhist, initial name K.H. ; a female in Tokyo, Japanese, aesthetic salon consultant, initial name K.O.

Examples are as followings:

1. Negative Cases of Bio-magnetic Field Emission (Figure 8) :

Thirty-four of the 37 subjects (examinees) did not exhibit magnetism. In 3 of the 34 negative cases, the magnetic waves in each measurement in 4 stages of time sequence were shown in Fig.8 ; control (before Qi emission), early stage (within one minute after Qi emission), middle stage (about 5 minutes after Qi emission), and post-stage (after interruption of the continuous 10 minutes Qi emission). Waveform in each of 4 stages of time sequence was almost flat as in controls with the exception of case 3 in the early

stage, of which the waveform might be an artifact by motor noise, etc. (Fig.8 arrow).

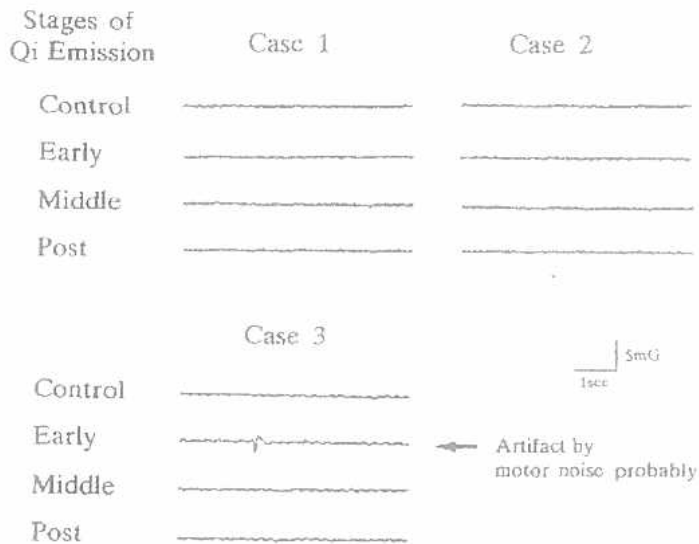

Fig. 8 : Negative cases of bio-magnetic field emission.
 Control; before Qi emission,
 Early stage; within one minute after Qi emission,
 Middle stage; about 5 minutes after Qi emission,
 Post stage; after interruption of continuous 10 minutes Qi emission.

2. Bio-magnetic Field Emission from the Palm of the Right Hand (Figure 9 to 11) :

Positive results were obtained in 3 subjects. A background magnetic field in the experimental room was measured without subjects at first (Pre-experiment as in Figs.9 to 11). All magnetic waveforms were flat, which indicated a stability of the measurement system and a low noise magnetic environment in and around the experimental room.

In the next step, magnetic field was measured under the subjects who were not emitting external Qi in the experimental room, and it was almost flat as same as the pre-experiment.

After the subjects emitted external Qi, each result was as follows:

i) M.I., ♂, in Sapporo, (Fig.9) :

Eighteen seconds after the Qi emission was initiated, a magnetic waveform (Fig.9, arrow) which was 3 milli-gauss (mGauss) (p-p), started to appear on oscilloscope. Subsequently, an average magnetic field strength of 2 mGauss (p-p) was detectable continuously till 40 seconds after the Qi emission. Moreover, an significant magnetic signal of a maximum of 4 mGauss (p-p), frequency from 4 to 6 Hz was observed after 50 seconds from the Qi emission was initiated. After the subject was emitting the Qi energy for 90 seconds, we sent a sign to interrupt the Qi emission. After interrupting the Qi emission by his own will, a reduced amplitude of the magnetic field appeared on oscilloscope, bringing the wave height down to almost the control level. In the post-experiment, that is, the subject leaving the experimental room, the magnetic waves became flat as those in the pre-experiment and the control stage.

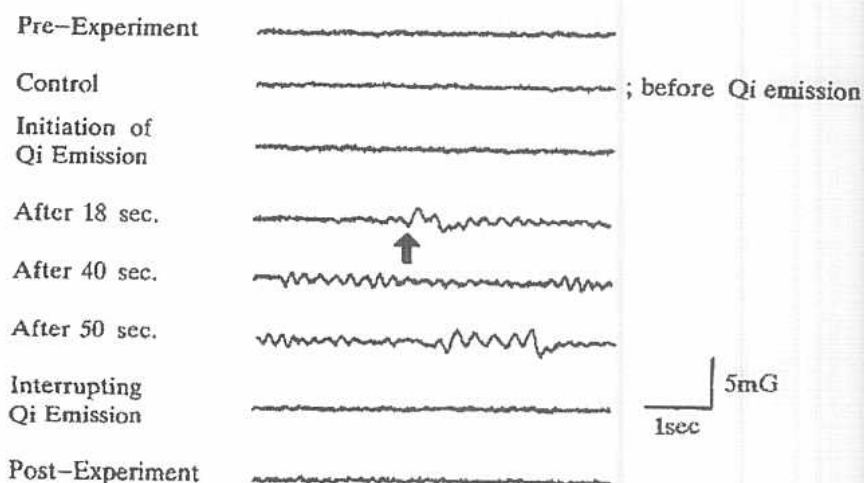

Fig. 9 : Positive result of mGauss order bio-magnetic field emission (I)
Subject; M.I., male in Sapporo, Japanese.

Strong bio-magnetic field emission from the palm was observed with 2 to 4 mGauss in frequency range of 4 to 6 Hz.

ii) K.H., ♀, in Sapporo, (Fig.10) :

Waveforms which measured in both the pre-experiment and the control were almost flat. Several seconds after the Qi emission was initiated, the first faint magnetic waveform appeared. However, 20 seconds were needed for an apparent wave of 2 mGauss (p-p) in the average to start appearing on oscilloscope. The subject was continuously radiating an average magnetic field strength of 2 mGauss and an average frequency of 7 Hz during 30 to 60 seconds after the Qi emission was initiated. The center frequency temporary changed to lower side, bringing to 5 Hz after 90 seconds. The

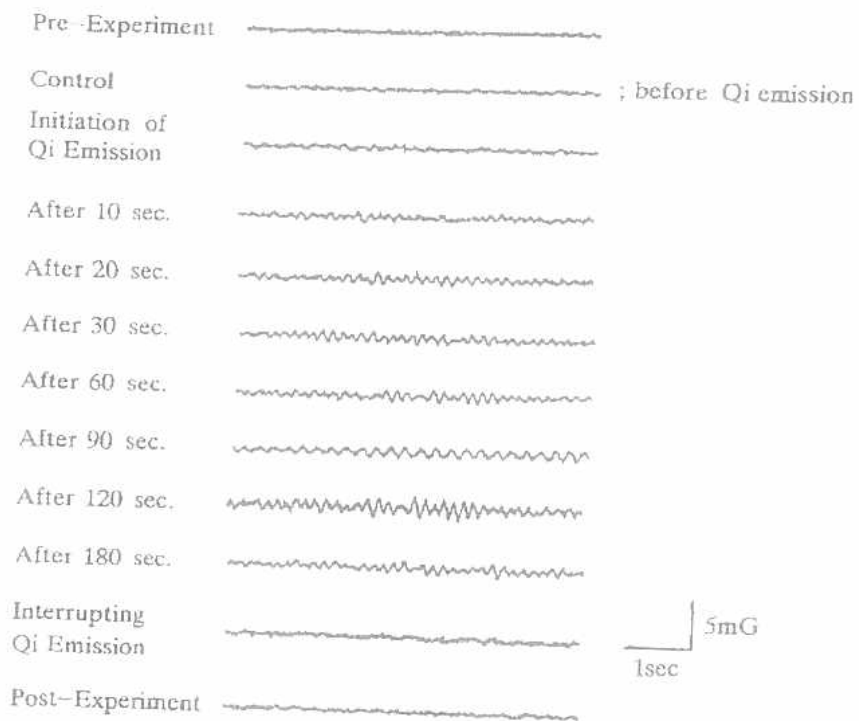

Fig.10 : Positive result of mGauss order bio-magnetic field emission (II)
Subject; K.H., female in Sapporo, Japanese.

Strong bio-magnetic field emission from the palm was observed with 2 to 3 mGauss in center frequency of 7 Hz.

amplitude of magnetism increased up to 3 mGauss (p-p) and the frequency was restored to 7 Hz in center, after 120 seconds. After interrupting the Qi emission by her own will, the amplitude of the magnetic waveform was brought back to the control level.

iii) K.O., ♀, in Tokyo, (Fig.11) :

In the pre-experiment, the magnetic background level was flat and without noises. When the subject entered into the experimental room, the flat base line on oscilloscope changed to a faint waving form. However, it was no problem to accept the magnetic field intensity as a control, because the magnetic field amplitude was low and very nearly flat. Thus, it should be ignorable. A weak magnetic field strength below 0.5 mGauss (p-p) appeared intermittently until 60 seconds after the Qi emission was initiated. The first apparent wave (Fig.11, arrow) which was an average magnetic field strength of 2 mGauss (p-p) and a frequency of 8 Hz to 10 Hz, was

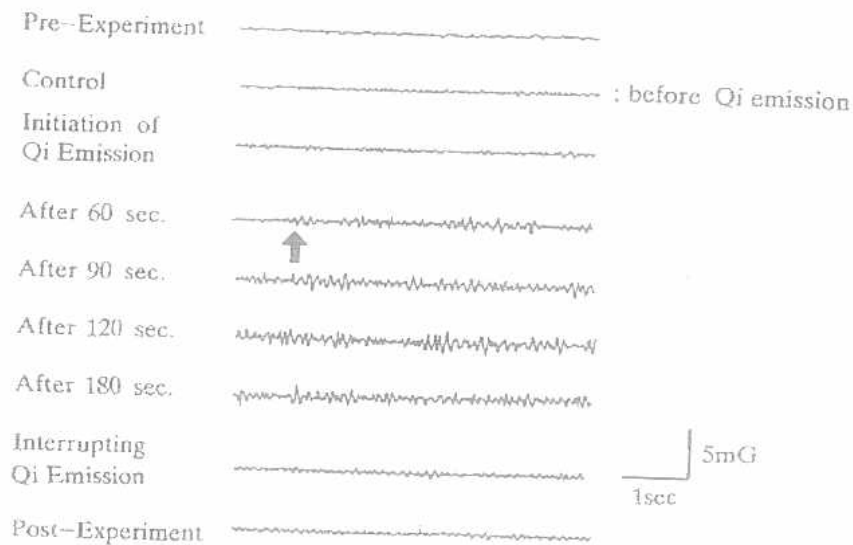

Fig.11 : Positive result of mGauss order bio-magnetic field emission (III)
Subject; K.O., female in Tokyo, Japanese.

Strong bio-magnetic field emission from the palm was observed with 2 to 3 mGauss in frequency range of 8 to 10 Hz.

observed after about 60 seconds from the Qi emission was initiated. Such a tendency continued furthermore for 60 seconds. The magnetic field amplitude raised up to 3 mGauss (p-p) or more, after 120 seconds. After interrupting the Qi emission by her own will, the magnetic field amplitude decreased very slowly down to the first control level, that is, not all the magnetic amplitude reduced quickly. She (the subject) said that it was more difficult for her consciousness to stop the Qi emission than to initiate.

3. Result of Simultaneous Measurement of Magnetism and Electricity (Fig.12) :

As described before, the subject K.H. (♀, in Sapporo, female Buddhist) was able to send out Qi from her palm, which was observed clearly as bio-magnetic emission. In this time, we measured both of her bio-magnetic field strength and bio-electric current simultaneously. Several minutes later after Qi emission, although her stable bio-magnetic emission was found continuously (Fig.12, above), the corresponding bio-electric current from the palm did not appear (Fig.12, below).

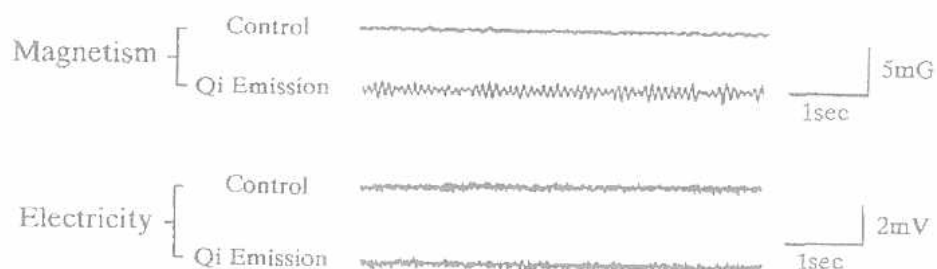

Fig.12 : Simultaneous measurement of bio-magnetic field emission and its corresponding bio-electric current.

Subject; K.H., female Buddhist, in Sapporo, Japanese.

Although her stable bio-magnetic field emission was observed continuously (above), its corresponding bio-electric current from the palm did not appear (below).

This result indicated that the human extraordinary large bio-magnetic field strength is never derived from the internal body current alone.

DISCUSSION

Individual Difference Among the Three Positive Subjects :

Although the extraordinary bio-magnetism was detected from 3 subjects, each of them had independent character in oriental medicine.

The subject M.I. (male, high school teacher) has a special bio-magnetic ability, but he did not get any special practice for external Qi emission till now. However, he said that he has a great interest in "Qi(氣) emission", is able to feel a flow of the Qi, and recently he seems to be able to emit the external Qi from the palm. It is considered that the interest in the Qi which activated his own latent ability to emit the external Qi, induced the extraordinary large bio-magnetic field emission.

The subject K.H. (female Buddhist) is endowed by nature with a special ability such as hand power healing. In fact, she is a female Buddhist now, and has been serving as a healer, too. In the present experiment, until the experiment was finished, we did not know her occupation and of course her special healing, too. It is considered that the persons who are said to have a healing ability with the external Qi can often radiate stronger magnetism than 10^{-6} gauss order.

The subject K.O. (female, aesthetic salon consultant) is a student of Qi Gong (氣功, called "Ki-Kou" in Japan) school. She was training the Qi Gong for about a half year. The main training was breathing method during Qi Gong exercise. She said that she has a healing ability with external Qi, too.

We can find a common ground for a special ability of emitting magnetic field among three subjects. All of the three subjects have a special ability to catch a certain feeling induced by Qi. The ability is sometimes given by nature, and sometimes obtained by the practice such as Qi Gong exercise.

One point which we are going to mention at this stage is that not all persons who are practicing external Qi emission are able to radiate the extraordinary large bio-magnetic field strength. Contrary, the extraordinary large bio-magnetic field must be radiated by the will to emit the external Qi. Although the will is absolutely needed in order to radiate the extraordinary large bio-magnetic field, its physiological mechanism remains still unknown.

Difference between Usual Bio-magnetic Field Strength and Extraordinary Large bio-magnetic Field Strength in Human Hand :

An extraordinary large human bio-magnetic field emission found in the present experiment, is a phenomenon which must be separated from the normally existing bio-magnetic field strength, since this special emission has very strong magnetic field strength which is unlikely to be produced under normal physiological conditions.

The magnetic field strength emitted in the normal condition, is extremely weak and usually less than 10^{-6} gauss order [1-3]. The sensitivities of ordinary magnetometers using Hall elements or coils as a sensor, are usually lower than 10^{-6} gauss. Therefore, these kinds of magnetometers are not able to sufficiently detect the extremely weak bio-magnetism in normal human body. On the other hand, sensitivity of SQUID (Superconducting Quantum Interference Device) magnetometer has 10^{-10} gauss or more [8-10], if the SQUID is used, MCG and MEG can be measured from everyone. (MCG; Magneto-Cardio-Gram, MEG; Magneto-Encephalo-Gram).

The magnetic field strength detection system in our experiment does not provide a high sensitivity enough to detect the usual human bio-magnetism such as MCG or MEG. Therefore, most magnetic field signals from the subjects (34 of 37 subjects) were clearly negative. If we provided the SQUID instead of the coils to the experiment, we must be able to detect the extremely weak bio-magnetism from any individual.

Contrary to this, the magnetic field emission obtained by this experiment was an astonishing phenomenon, since the present stronger magnetic field is 1,000 times or more intensity than heart's bio-magnetism.

In this phenomenon, the emission of very strong bio-magnetic field in the order of mGauss can not be understood by the current common sense on bio-magnetism. Thus, this bio-magnetic field emission is an amazing phenomenon with its unique characteristic and origin.

Is Extraordinary Large Bio-magnetic Field Derived from Internal Body Current ? :

We detected high bio-magnetic field signals in 3 subjects. If the magnetic field signals were assumed to be deriving from internal body electric current, the corresponding current should be induced in the palm. If the bio-magnetic field of

mGauss order was converted into its corresponding electric body current, the converted bio-current should be at least order of 10 mA. However, the living body cannot usually generate and supply any such large current by its self. In fact, no electric shock attacked her. The living body usually can not supply such strong bio-electric current with the exception of special dynamo electric organs as found in electric eel. Therefore, possibility of having such strong bio-electric current in human body is difficult to comprehend.

Although it was one example, we encountered the following interesting phenomenon. The subject K.H. (♀, in Sapporo, female Buddhist) was able to send out Qi energy from her palm, which was observed clearly as strong bio-magnetic field emission. At that time, we measured both of her bio-magnetic field strength and bio-electric current simultaneously. However, during her stable magnetic field emission, an expected corresponding bio-electric current did not appear at all (Fig.12). This result indicated that the human extraordinary large bio-magnetic field strength is never derived from the internal body current alone.

Extraordinary Large Bio-magnetic Field Emitted from Human Hand; its Uncertain Origin :

From above, it is impossible to explain the origin of the extraordinary large bio-magnetic field strength in terms of bio-electric currents alone. Moreover, the frequency band of the special bio-magnetism deviates from an established physiological common sense. The emission of an extremely low frequency magnetic field of about 7 to 10 Hz from the palm is equivalent to the flowing the electric current through the palm with same frequency. So far as the frequency, such a current source as the extremely low frequency is not found in the human body except brain wave. However, the bio-magnetic field strength derived from the brain wave (MEG) is extremely low intensity with 10^{-8} gauss order or less [9]. Thus, the brain electric current must be far from the origin of the extraordinary large bio-magnetic field strength.

In a similar way of thinking, the frequency and the intensity of the extraordinary large bio-magnetism differ quite from those of electromyogram, of which frequency is about less than 200 Hz and intensity is less than 10^{-7} gauss order. The muscle electric current also must be beyond a

possibility of the origin. Therefore, we can not find the internal body current which corresponds to extremely large current in order of 10 mA.

The large human bio-magnetic field emission in this experiment is not only exceeding usual but also astonishingly special in every respect. The origin of the human extraordinary large bio-magnetic field remains still uncertain.

" Qi(氣) " as Origin of Human Extraordinary Large Bio-magnetic Field :

It is necessary to specify a true origin of the bio-magnetic field emitted from the palm of unusual individual. The human body usually cannot secure the current source of strength which is necessary for generation of the extraordinary large bio-magnetic field in the order of mGauss. Therefore, another energy source which is equivalent to the large current flow, must exist by all means, as an origin of the human extraordinary large bio-magnetic field.

In order to resolve a contradiction of a quantitative issue, we assume the existence of a parameter such as another energy source in the human body. Another energy in the body is indeed considered as something extremely close to the true nature of unidentified " Qi(氣) " energy.

Qi is not magnetic field but "deep force" behind our observable dimension rather than existing physical quantity such as magnetic field.

CONCLUSION

We detected continuously extraordinary large bio-magnetic field emissions which generated from the human palm in 3 subjects during external Qi(氣) emission.

The bio-magnetic field strength at the palm of the hand of these 3 subjects was 2 to 4 mGauss (10^{-3} gauss), and was greater than that of normal human bio-magnetic field strength by 1,000 times at least.

The frequency of the bio-magnetism was 4 to 10 Hz.

REFERENCES

- 1) Baule,G.M. and McFee,R.: Detection of the magnetic field of the heart. Am. Heart J., Vol.66(1), pp95-97,1963.
- 2) Cohen,D.: Magnetic fields around the torso; Production by electrical activity of the human heart. Science, Vol.156, pp652-654,1967.
- 3) Cohen,D.: Magnetoencephalography; Evidence of magnetic fields produced by alpha-rhythm currents. Science, Vol. 161, pp784-786,1968.
- 4) Omura,Y.,Lin.T-L.,Debreceni,L.,Losco,M.,Freed,S.Muteki,T., and Lin,C.: Unique changes found on the Qi Gong (Chi Gong) master's and patient's body during Qi Gong treatment; their relationships to certain meridians & acupuncture points and the re-creation of therapeutic Qi Gong states by children & adults, Acupuncture & Electro-Therapeutics Research. The International Journal,Vol.14, pp61-89,1989.
- 5) Omura,Y.: Connections found between each meridian (heart, stomach, triple burner,etc.) & organ representation area of corresponding internal organs in each side of the cerebral cortex; release of common neurotransmitters and hormones unique to each meridian and corresponding acupuncture ture point & internal organ after acupuncture, electrical stimulation, mechanical stimulation (including shiatsu),soft laser stimulation or Qi Gong, Acupuncture & Electro-Therapeutics Research.The International Journal, Vol.14, pp155-186,1989.
- 6) Omura,Y.: Storing of Qi Gong energy in various materials and drugs (Qi Gongnization); its clinical application for treatment of pain, circulatory disturbance,bacterial or viral infections,heavy metal deposits, and related intractable medical problem by selectively enhancing circulation and drug uptake, Acupuncture & Electro-Therapeutics Research.The International Journal, Vol.15, pp137-157,1990.

- 7) Mori,H.: Acupuncture points and meridians according to the international numbering system; an illustrated guide. (解剖経穴図), Idoh no Nippon-Sya (医道の日本社), Yokosuka, Japan, 1988. (in Japanese)
- 8) Cohen,D.,Edelsack,E.A.,and Zimmerman,J.E.: Magnetocardiograms taken inside a shielded room with a superconducting point-contact magnetometer. Appl. Phys., Vol.16(7), pp278-280,1970.
- 9) Cohen,D.: Magnetoencephalography; Detection of the brain electrical activity with a superconductivity magnetometer. Science, Vol.175, pp664-666,1972.
- 10) Shirae,K.,Furukawa,H.,and Kishida,K.: A new multielement SQUID system and its application to the magnetic vector gradiometer. Cryogenics, Vol.21, pp707-709,1981.